

211.

Spine mobili
per uso industriale - IP44

SPINE MOBILI - 16A e 32A

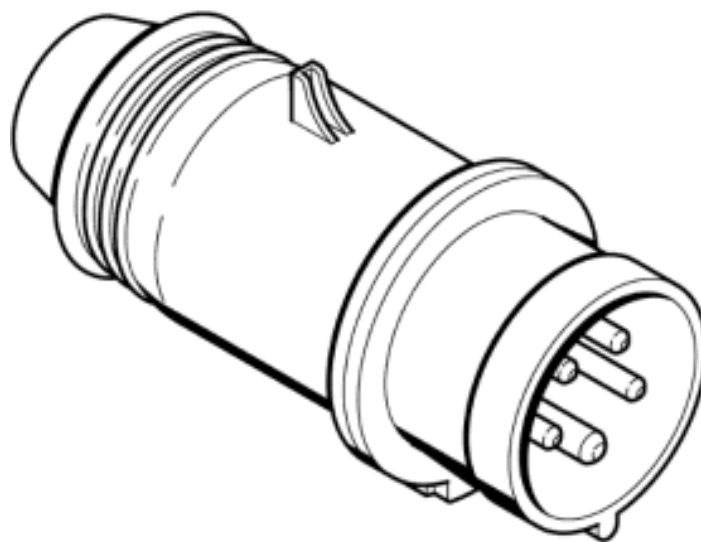







Uscita diritta



Serie EUREKA

- Norme di riferimento:
CEI 23-12/1 e
CEI 23-12/2
- Generalità: sez. 2.2



















Versioni per uso comune

Poli	Hz	Volt	h.	Codice articolo	
				16A	32A
2P+ T	50/60	100-130	 4	211.1630	211.3230
	50/60	200-250	 6	211.1633	211.3233
	50/60	380-415	 9	211.1638	211.3238
3P+ T	50/60	100-130	 4	211.1631	211.3231
	50/60	200-250	 9	211.1634	211.3234
	50/60	380-415	 6	211.1636	211.3236
3P+ N+ T	50/60	100-130	 4	211.1632	211.3232
	50/60	208-250	 9	211.1635	211.3235
	50/60	346-415	 6	211.1637	211.3237

Prodotti con marchio IMQ

Versioni per usi specifici

Codice articolo

Poli	Hz	Volt	h.	16A	32A
2P+ T	60	277		5 211.16337	211.32337
	50/60	480-500		7 211.16336	211.32336
	50/60	trasf.		12 211.16333	211.32333
	> 300-500	> 50		2 211.16332	211.32332
	c.c.	> 50-250		3 211.16334	211.32334
	c.c.	> 250		8 211.16338	211.32338
3P+ T	60	440-460		11 211.16365	211.32365
	50/60	480-500		7 211.16366	211.32366
	50/60	600-690		5 211.16367	211.32367
	50/60	trasf.		12 211.16363	211.32363
	50 60	380 440		3 211.16364	211.32364
	100-300	> 50		10 211.16361	211.32361
	> 300-500	> 50		2 211.16362	211.32362
3P+ N+ T	50/60	480-500		7 211.16376	211.32376
	50/60	600-690		5 211.16377	211.32377
	60	440-460		11 211.16375	211.32375
	50 60	380 440		3 211.16374	211.32374
	> 300-500	> 50		2 211.16372	211.32372

Prodotti con marchio IMQ