

216.

Spine mobili
per uso industriale - IP67

SPINE MOBILI - 16A e 32A







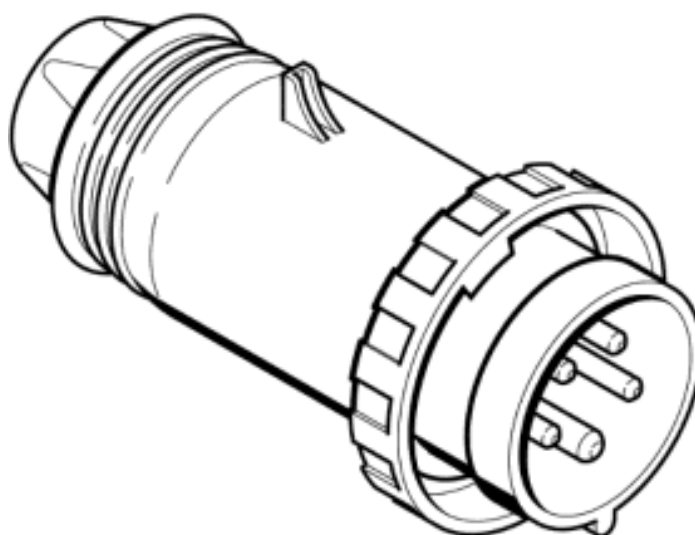

Uscita diretta

Serie EUREKA

- Norme di riferimento:
CEI 23-12/1 e
CEI 23-12/2
- Generalità: sez. 2.2





















Versioni per uso comune

Poli	Hz	Volt	h.	Codice articolo	
				16A	32A
2P+ T	50/60	100-130	 4	216.1630	216.3230
	50/60	200-250	 6	216.1633	216.3233
	50/60	380-415	 9	216.1638	216.3238
3P+ T	50/60	100-130	 4	216.1631	216.3231
	50/60	200-250	 9	216.1634	216.3234
	50/60	380-415	 6	216.1636	216.3236
3P+ N+ T	50/60	100-130	 4	216.1632	216.3232
	50/60	208-250	 9	216.1635	216.3235
	50/60	346-415	 6	216.1637	216.3237

Prodotti con marchio IMQ

Versioni per usi specifici

Codice articolo

Poli	Hz	Volt	h.	16A	32A
2P+ T	60	277		5 216.16337	216.32337
	50/60	480-500		7 216.16336	216.32336
	50/60	trasf.		12 216.16333	216.32333
	>300-500	>50		2 216.16332	216.32332
	c.c.	>50-250		3 216.16334	216.32334
	c.c.	>250		8 216.16338	216.32338
3P+ T	60	440-460		11 216.16365	216.32365
	50/60	480-500		7 216.16366	216.32366
	50/60	600-690		5 216.16367	216.32367
	50/60	trasf.		12 216.16363	216.32363
	50 60	380 440		3 216.16364	216.32364
	100-300	>50		10 216.16361	216.32361
	>300-500	>50		2 216.16362	216.32362
	3P+ N+ T	50/60	480-500		7 216.16376
50/60		600-690		5 216.16377	216.32377
60		440-460		11 216.16375	216.32375
50 60		380 440		3 216.16374	216.32374
>300-500		>50		2 216.16372	216.32372

Prodotti con marchio IMQ