

316.

Prese mobili
per uso industriale - IP67

PRESE MOBILI - 16A e 32A







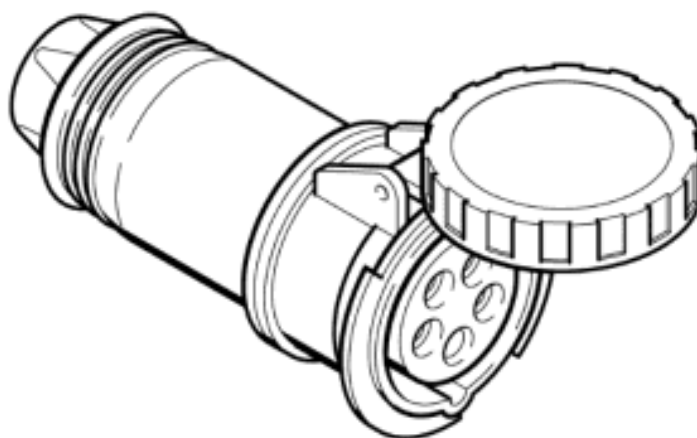

Uscita diretta

Serie EUREKA

- Norme di riferimento:
CEI 23-12/1 e
CEI 23-12/2
- Generalità: sez. 2.2





















Versioni per uso comune

Poli	Hz	Volt	h.	Codice articolo	
				16A	32A
2P+ T	50/60	100-130	 4	316.1640	316.3240
	50/60	200-250	 6	316.1643	316.3243
	50/60	380-415	 9	316.1648	316.3248
3P+ T	50/60	100-130	 4	316.1641	316.3241
	50/60	200-250	 9	316.1644	316.3244
	50/60	380-415	 6	316.1646	316.3246
3P+ N+ T	50/60	100-130	 4	316.1642	316.3242
	50/60	208-250	 9	316.1645	316.3245
	50/60	346-415	 6	316.1647	316.3247

Prodotti con marchio IMQ

Versioni per usi specifici

Codice articolo

Poli	Hz	Volt	h.	16A	32A
2P+ T	60	277		5 316.16437	316.32437
	50/60	480-500		7 316.16436	316.32436
	50/60	trasf.		12 316.16433	316.32433
	> 300-500	> 50		2 316.16432	316.32432
	c.c.	> 50-250		3 316.16434	316.32434
	c.c.	> 250		8 316.16438	316.32438
3P+ T	60	440-460		11 316.16465	316.32465
	50/60	480-500		7 316.16466	316.32466
	50/60	600-690		5 316.16467	316.32467
	50/60	trasf.		12 316.16463	316.32463
	50 60	380 440		3 316.16464	316.32464
	100-300	> 50		10 316.16461	316.32461
	> 300-500	> 50		2 316.16462	316.32462
3P+ N+ T	50/60	480-500		7 316.16476	316.32476
	50/60	600-690		5 316.16477	316.32477
	60	440-460		11 316.16475	316.32475
	50 60	380 440		3 316.16474	316.32474
	> 300-500	> 50		2 316.16472	316.32472

Prodotti con marchio IMQ